

1 2 3 4 5 6 7 8

A
B
C
D
E
F

A
B
C
D
E
F

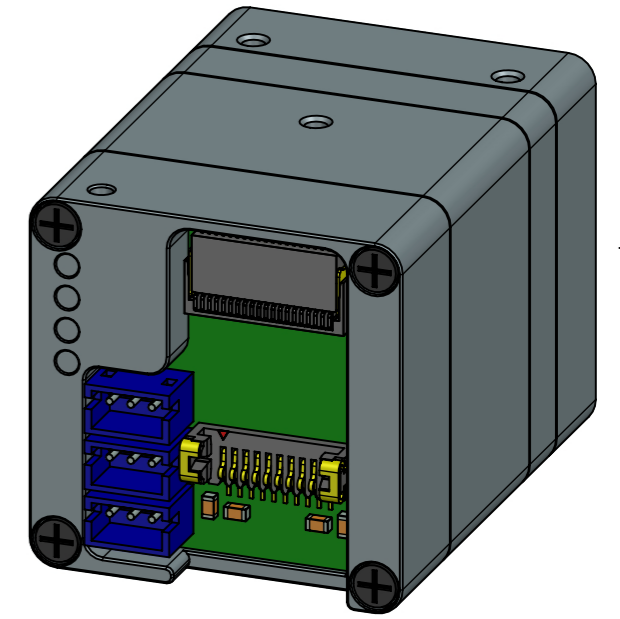
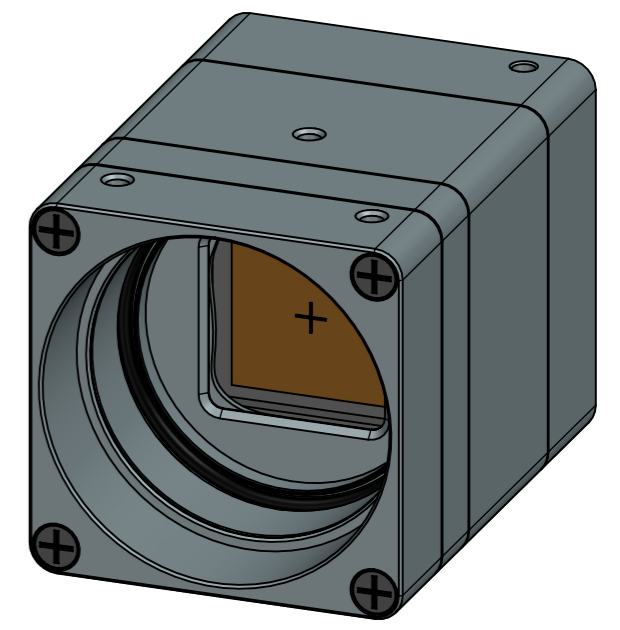
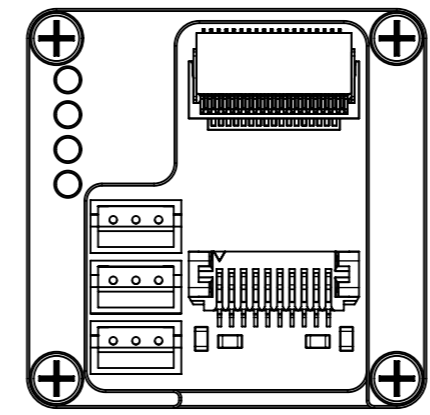
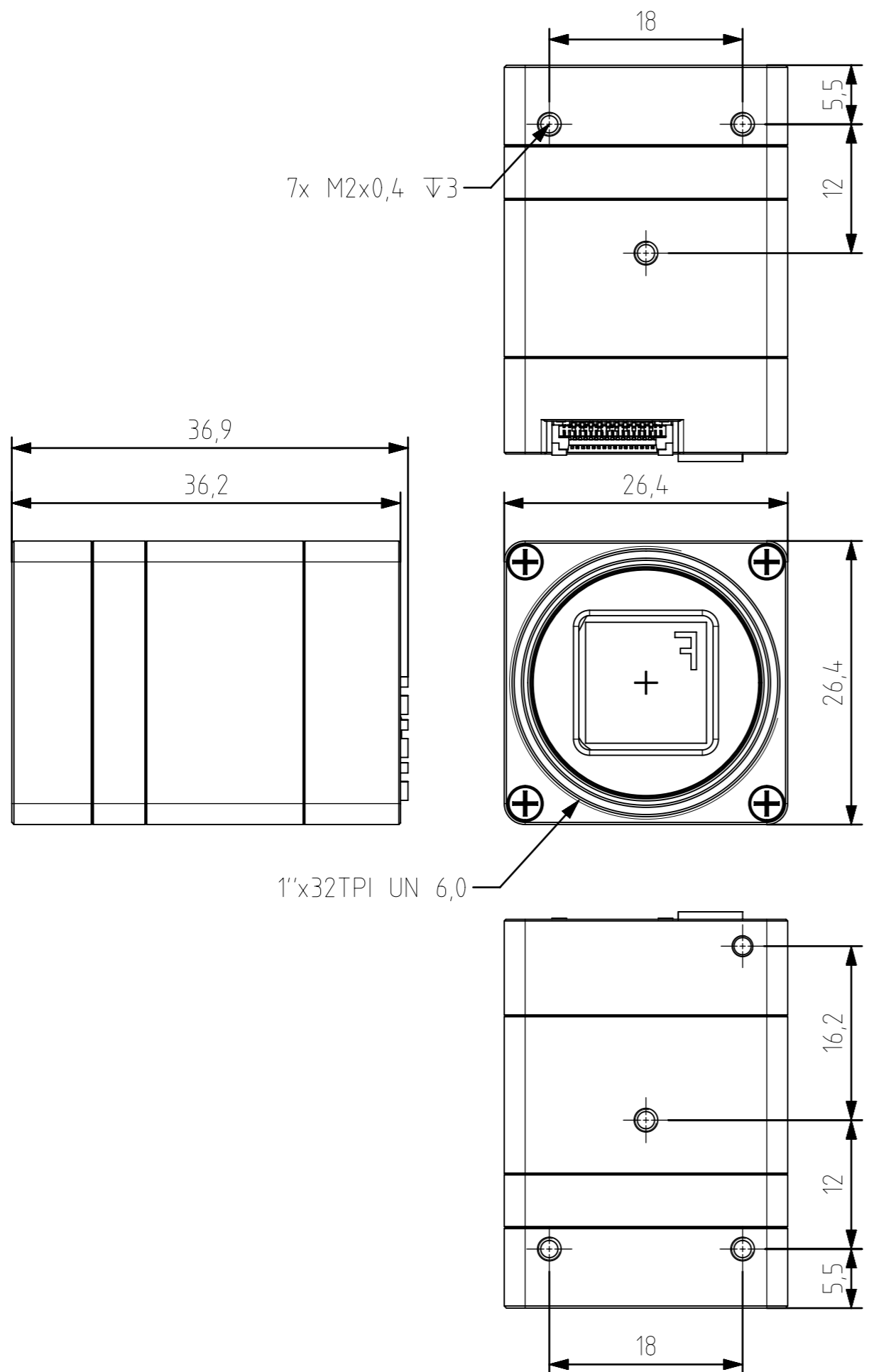

This drawings is the property of XIMEA s.r.o. No use thereof shall be made other than as a reference for proposals as submitted to XIMEA s.r.o. for jobs to be executed in conformity with such proposals unless the consent of said XIMEA s.r.o. has previously been obtained. No part of this drawing shall be copied or duplicated or its contents disclosed. The information contained on this drawing is confidential and proprietary.

Date:	Name:	PN:	Customer PN:	Surface Quality:
Designed -	R&D	MX042xG-SY-X2G2-FF	Material:	Surface Finish:
Drawn 20200207	GS			
Approved 20200207	GS	Project Class	First angle projection	Weight: g
QC 20200207	GS			
MFGP 20200207	GS	Department: R&D	Units: mm	Scale: 2:1
Default tolerances: ISO2768-1				
Change Date Name			Doc Type: EU	PART REVISION
Document Nr:				
			DOCUMENT REVISION	Page: 1 of 1

1 2 3 4 5 6 7 8 A3