

1 2 3 4 5 6 7 8

A

B

C

D

E

F

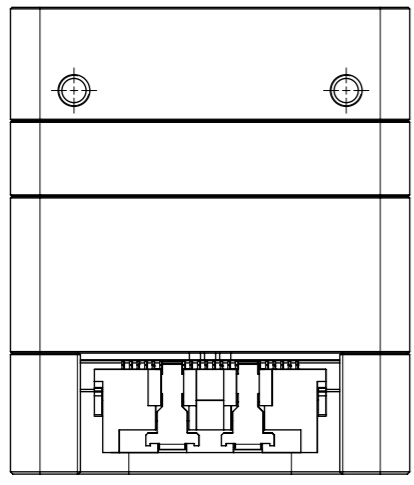
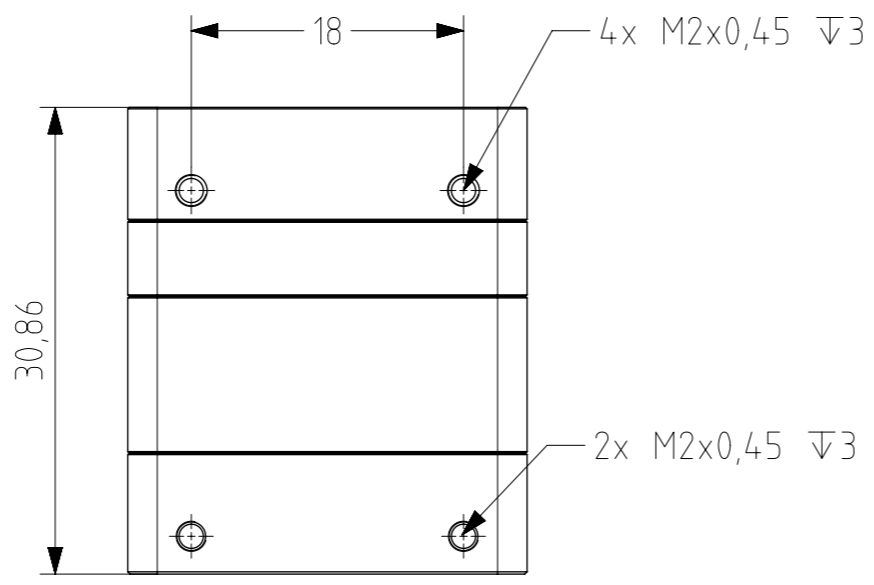
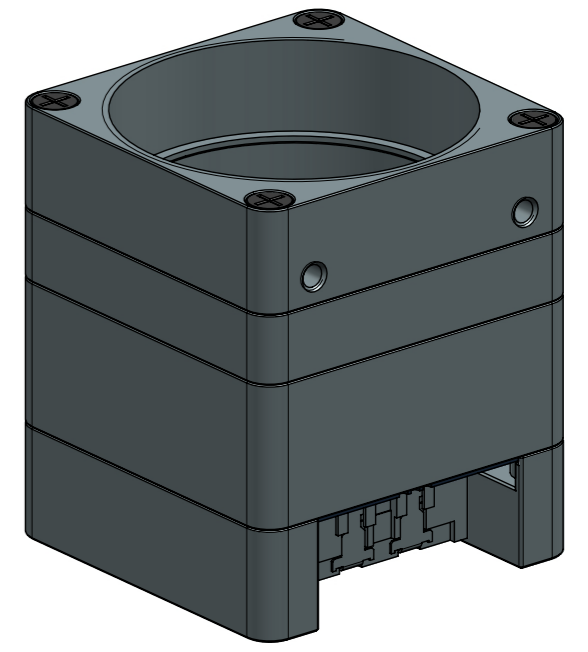
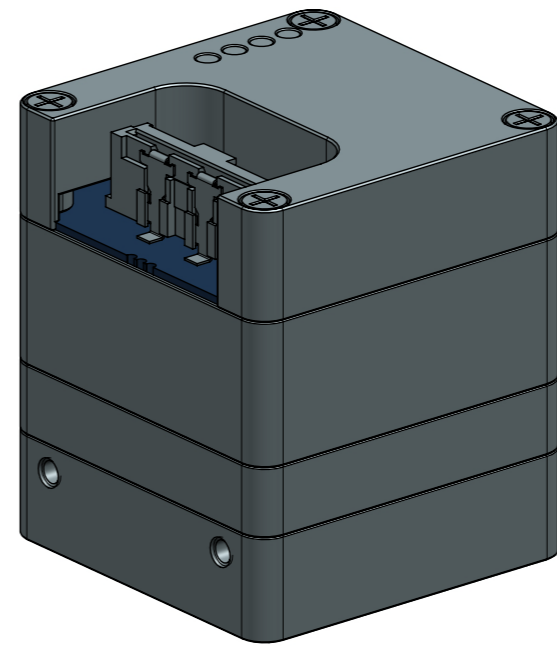
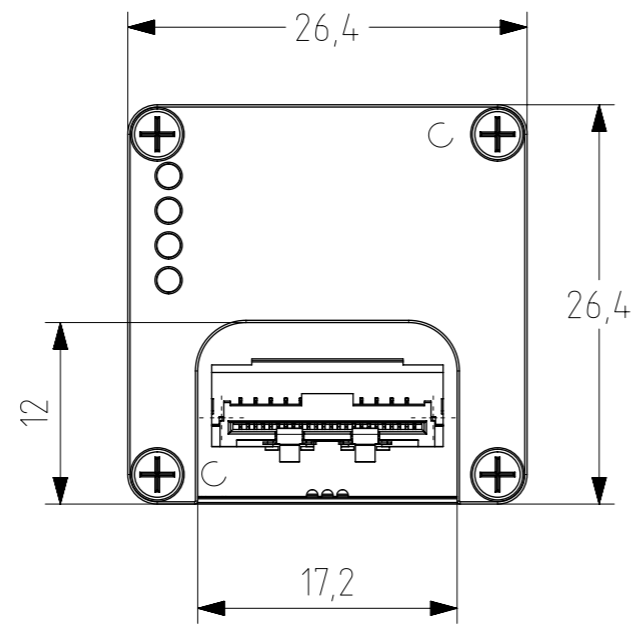

Date:	20150202	Name:	KLIMKOVIC	PN:	MX089MG-SY-X2G2-FV	Customer PN:	NA	Surface Quality:	
Designed	20150202	Drawn	20160707	Approved	20160707	Material:		Surface Finish:	OPTICAL BLACK
QC	20160707	MFGP	20160707	Project Class		First angle projection		Weight:	
Department:	R&D	Default tolerances:	ISO2768-1	MX		Units:	mm	Scale:	1:1
				Change	Date	Name	Format	A3	
				Edges ISO 13715		Doc Type:	EU	Part Doc:	Version Revision
				Surface ISO 1302				1.0	Page:
								1 of 1	

This drawings is the property of XIMEA GmbH. No use thereof shall be made other than as a reference for proposals as submitted to XIMEA GmbH for jobs to be executed in conformity with such proposals unless the consent of said XIMEA GmbH has previously been obtained. No part of this drawing shall be copied or duplicated or its contents disclosed. The information contained on this drawing is confidential and proprietary.

1 2 3 4 5 6 7 8